

BUTAFIX®

Trellising Solutions

GALVANISED METAL POST



54 x 60 mm Profile

Band Wide : 180 mm
 Usage : Anchor post for more
 100 m
 Trellising Type :
 Pergola, High System
 Length : 220 - 450 cm
 Thickness :
 • 2,00mm
 • 2,50 mm



52 x 44 mm Profile

Band Wide : 127 mm
 Usage : Anchor post
 Trellising Type : Fencing,
 Winegrowing, Double T,
 Pergola, High System
 Length : 220 - 450 cm
 Thickness :
 • 1,80mm
 • 2,00mm
 • 2,50 mm



52 x 35 mm Profile

Band Wide : 110 mm
 Usage : Intermediate post
 Trellising Type: Fencing,
 Winegrowing, Double T,
 Length : 200 - 300 cm
 Thickness:
 • 1,50mm

Manual Post Drive

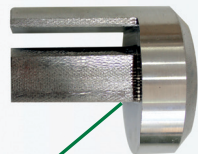
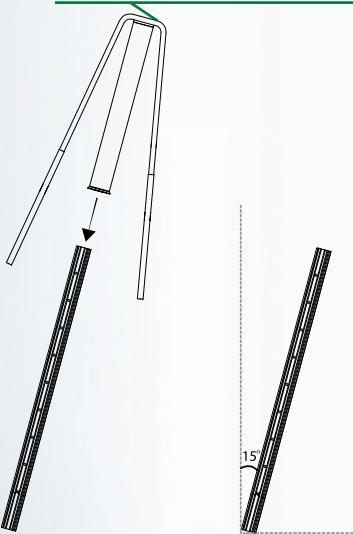

Impact Protector

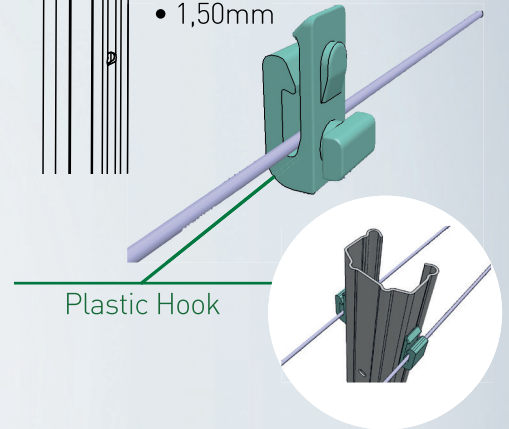

Plastic Hook

i Installation of Anchor Rope :

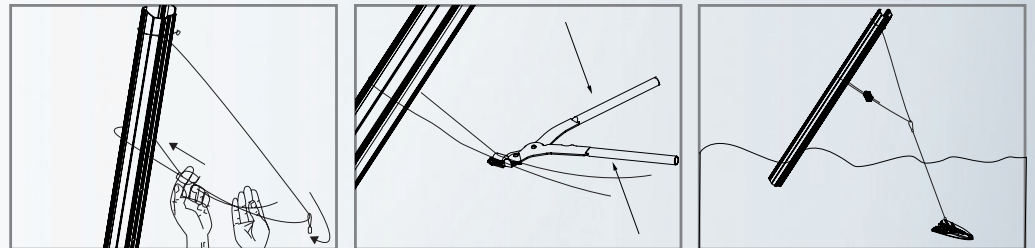

i Installation of Anchor Post

Plastic Sharpness Stopper



Crossarm

Crossarm for Anchor Post

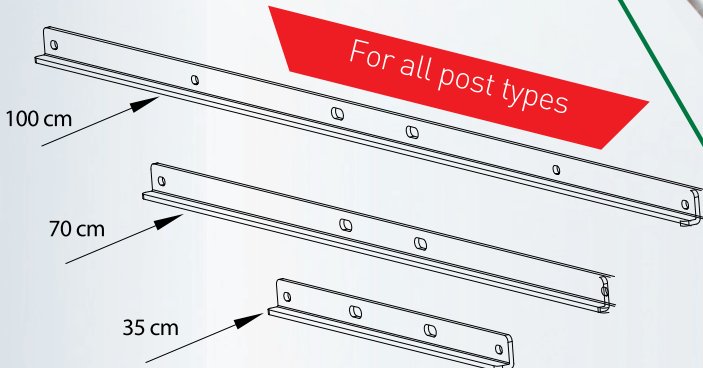

Post Wide: 5 cm - 12 cm

i Cross-Drilled Holes

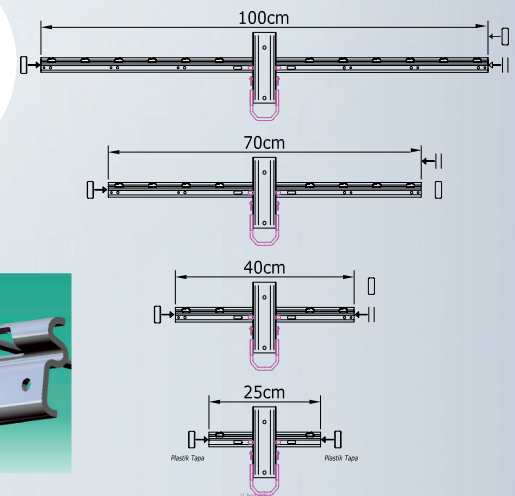
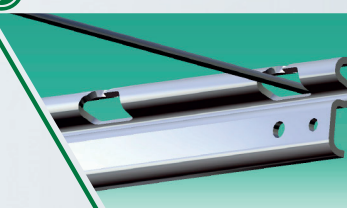

Wire Tensioner

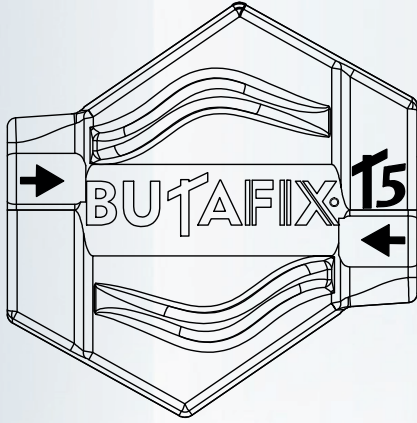

BUTAFIX® T5

- Diameter: 3,60mm - 5,20mm
- Maximum Working Load: 900 kg
- Double Hole
- Designed with reset hole

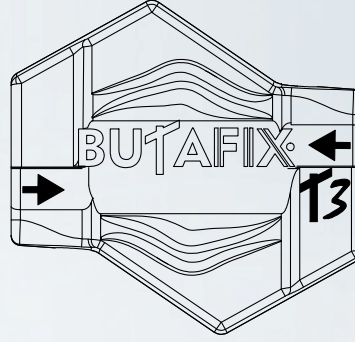

BUTAFIX® T3

- Diameter: 2,00mm - 3,60mm
- Maximum Working Load: 700 kg
- Double Hole
- Designed with reset hole

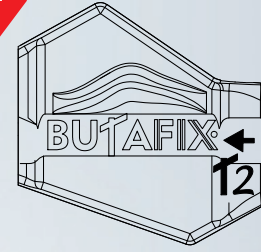

BUTAFIX® T2

- Diameter: 1,50mm - 3,00mm
- Maximum Working Load: 600 kg
- Single Hole
- Designed with reset hole

High grade ceramic roller

PATENT



Suitable for all tensioner

Professional Tensioning Tool

Tensioning Tool is a wire tensioner tool that regulates the load applied to it, delivering consistent results and maximising the life of your wire.

Suitable for Butafix T5, T3, T2

Standard Land Anchor

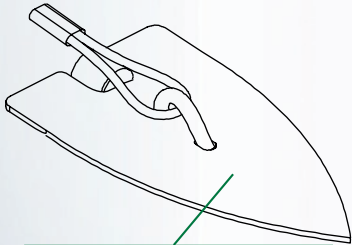

Sheet Metal Anchor

Maximum Working Load: 1200 Kg
Length of Rope : 80 - 120 cm
Diameter of Rope : 4 mm
Type of Rope : 1 x19 Hot Dip Galv.
Dimension : 115 x 200 mm
100 x 160 mm
Anchor: 3 - 4 mm

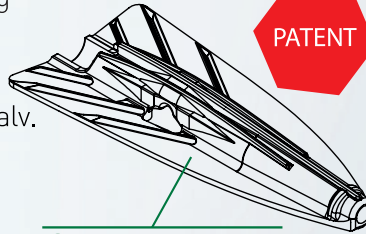

Casting Anchor

Premium Land Anchor

PATENT

Maximum Working Load: 900 Kg
Length of Rope : 100 cm
Diameter of Rope : 4 mm
Type of Rope: 1 x19 Hot Dip Galv.
Dimension : 80 x 170 mm
Anchor: Aluminum Alloy
Metal Casting

Manual Land Anchor Driver

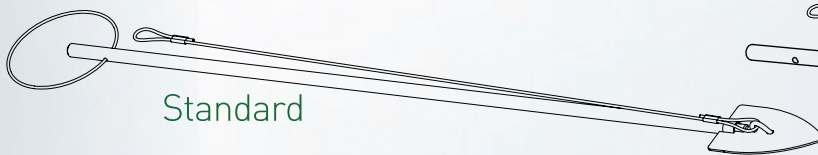

Standard

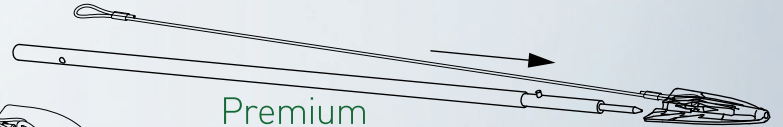

Premium

Installation of Land Anchor

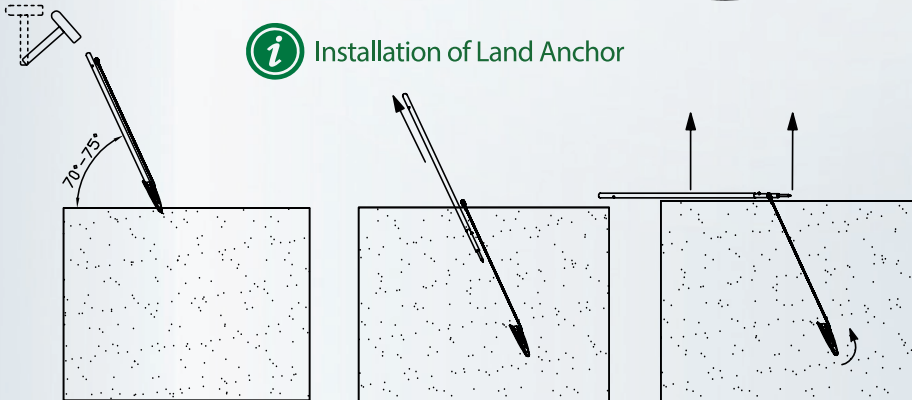

BUTAFIX®

BUTAFIX, is Trade Marked
by Bursa Fidancılık Tarım
Ltd. Şti.



Address : Çalı Mah. Atatürk Cd. No: 6 A/B
Nilüfer / Bursa / TURKEY

Tel: +90 224 482 27 70

Mobile: +90 533 604 86 24

E-mail: info@butafix.com

MADE IN TURKEY